

REGULATING GROUP WITH THERMOSTATIC MIXING VALVE DN 20

Description



Preassembled pump group for fixed point regulation and circulation of mixed fluid. Allows the circulation of the thermal fluid, coming from the primary circuit, by keeping the temperature at a pre-set value (fixed point) through the help of a mixing valve with thermostatic element. It is used in heating systems in general and radiant panel systems. The group is composed of a pump, flow/return shut-off valves, thermostatic mixing valve, flow/return temperature gauges, anti-thermosiphon check valve, thermal insulation. In this group, the differential by-pass can be installed only externally. The group is reversible (flow line can be exchanged with the return line). Male and female thread on system side connections.

BAFA
LIST

Range of products

Regulating group with thermostatic mixing valve	02G	XXX	XX	X	X
Male and female thread on system side connections G 1 M+G 3/4 F		020			
Without accessories			00		
Without pump				X	
Pump Wilo Para 15-130/7-50/SC-9				P	
Pump Grundfos UPM3 AUTO 15-70 130 				L	
Pump Grundfos UPSO 15-65 130 (Extra EU)				F	
Temperature adjustment range 30–60 °C					-
Temperature adjustment range 25–50 °C					E

 on request

Features

Working temperature range: **5–90 °C**
 Max working pressure: **10 bar**
 Female connections: **EN 10226-1**
 Male connections: **ISO 228-1**
 Connection centre distance: **90 mm**
 Pump: **Wilo Para 15-130/7-50/SC-9**
 Grundfos UPM3 AUTO 15-70 130 
 Grundfos UPSO 15-65 130 (Extra EU)
 Suitable fluids: **water, glycol solutions (max 30%)**
 Temperature adjustment range: **25–50 and 30–60 °C**
 Factory setting: **38 and 45 °C**
 Temperature gauge scale: **0–120 °C**

Materials

Ball valves

- Body: **brass EN12165 CW617N**
- Gaskets: **PTFE, EPDM, Viton**

Thermostatic mixing valve

- Body: **brass EN 12165 CW617N**
- Fitting and plug: **brass EN 12165 CW617N**
- Gaskets: **EPDM, asbestos free fiber**
- Spring: **stainless steel AISI 302**

Extension: **galvanized steel**
 T-joint: **brass EN12165 CW617N**

Check valve insert

- Body and obturator: **POM**
- Gasket: **NBR**

Pump

- Body: **cast iron**
- Electric supply: **230 V-50/60 Hz**
- Protection class:
 - Wilo Para: **IPx4D**
 - Grundfos UPM3: **IP 44**
 - Grundfos UPSO (Extra EU): **IP 44**
- Centre distance: **130 mm**
- Connections: **G 1 M (ISO 228-1)**

Insulation shell

- Body: **EPP**
- Density: **60 kg/m³**
- Working temperature range: **-5–120 °C**
- Thermal conductivity: **0,04 W/(m·K)**

REGULATING GROUP WITH THERMOSTATIC MIXING VALVE DN 20

Components

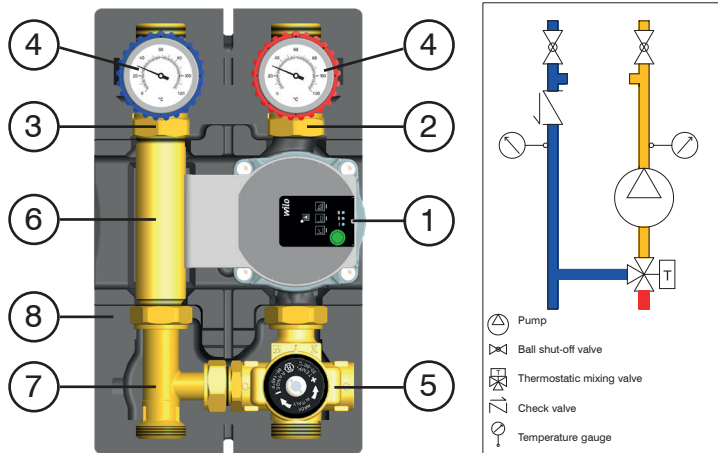

02G.DN20		
1	Pump	Wilo Para, Grundfos UPM3 AUTO, Grundfos UPSO (Extra EU)
2	Ball shut-off valve	
3	Ball shut-off valve with check valve	
4	Temperature gauge	
5	Thermostatic mixing valve	
6	Extension	
7	T-joint	
8	Insulation shell	

Dimensions

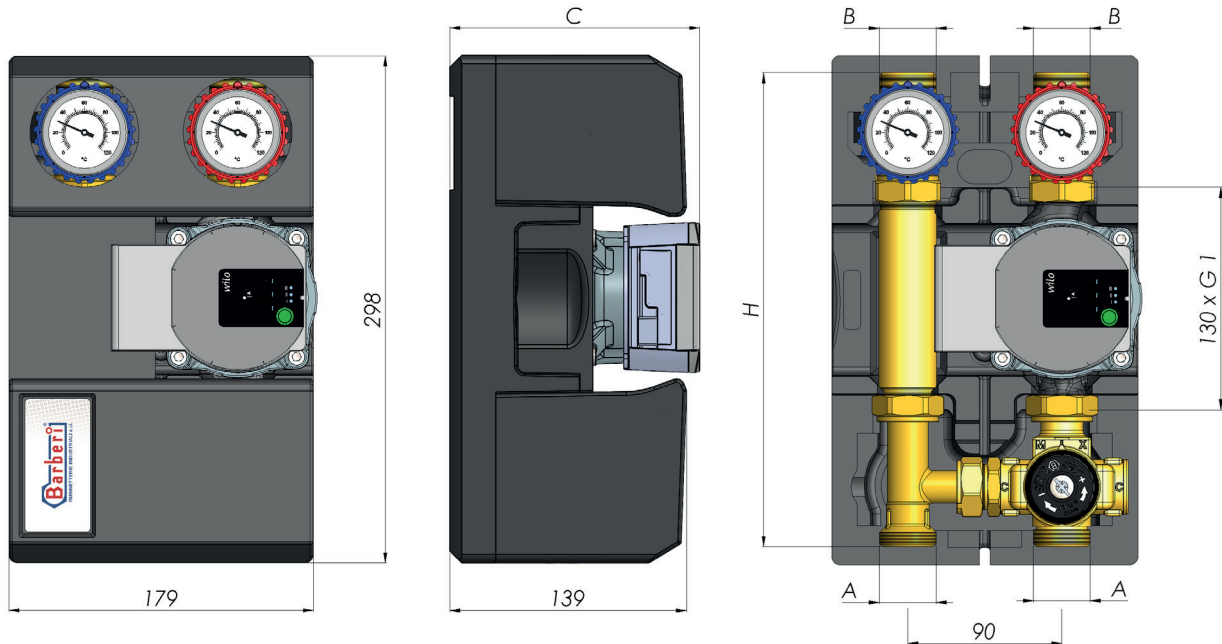

Code	P [bar]	A	B	C [mm]	H [mm]	Pump	Weight [kg]	N. P/B	N. P/C
02G 020 00X(E)	10	G 1 M	G 1 M+G 3/4 F	-	277	Without pump	2,6	-	1
02G 020 00P(E)	10	G 1 M	G 1 M+G 3/4 F	147	277	Wilo Para 15-130/7-50/SC-9	4,1	-	1
02G 020 00L(E) 	10	G 1 M	G 1 M+G 3/4 F	145	277	Grundfos UPM3 AUTO 15-70 130	4,3	-	1
02G 020 00F(E)	10	G 1 M	G 1 M+G 3/4 F	156	277	Grundfos UPSO 15-65 130 (Extra EU)	5,1	-	1

N. P/B: number of pieces in box - N. P/C: number of pieces in carton
Other pump types should be evaluated

REGULATING GROUP WITH THERMOSTATIC MIXING VALVE DN 20

Diagrams

Group sizing (operation for specialized/authorized technical personnel).

Step 1: head losses of the group without pump. Enter on the x-axis of the first diagram with the design flow rate value. Cross the curve of the group and read the corresponding head losses of the group (without pump) on the y-axis.

Step 2: available head of the pump. With the same design flow rate value, enter on the x-axis of the selected pump diagram ("Head of pump"). Cross the curve of the selected working mode (Constant speed, Proportional pressure, Constant pressure) and read the corresponding available head of the pump on the y-axis.

Step 3: pump validation. Calculate the difference between the available head of the pump and the head losses of the group without pump. The remaining pump head should be higher than the head losses of the rest of the system: if so, the selected pump is suitable to supply water to the rest of the system, otherwise a different pump working mode or pump size or different group size or a system resizing could be necessary.

Hydraulic characteristics: head losses of the thermostatic regulating group without pump

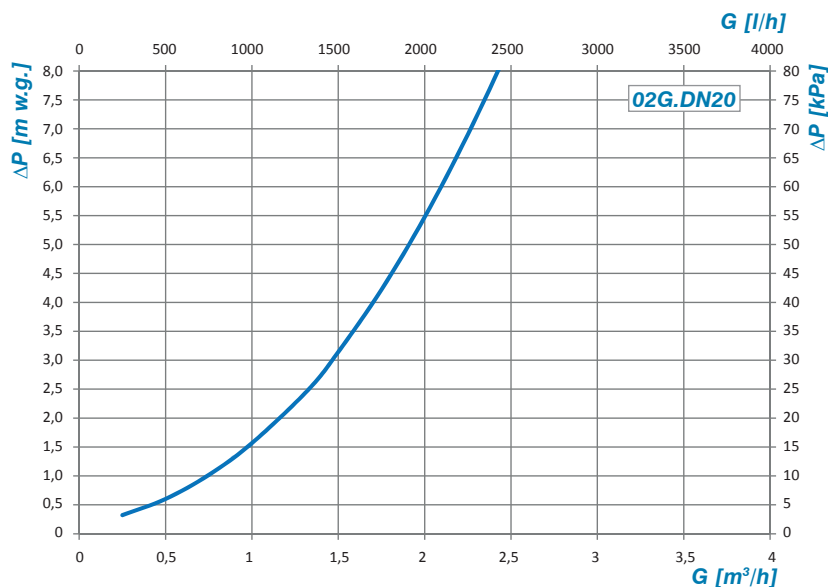

Head and power consumption of the pumps

Head of pump Wilo Para 15-130/7-50/SC-9

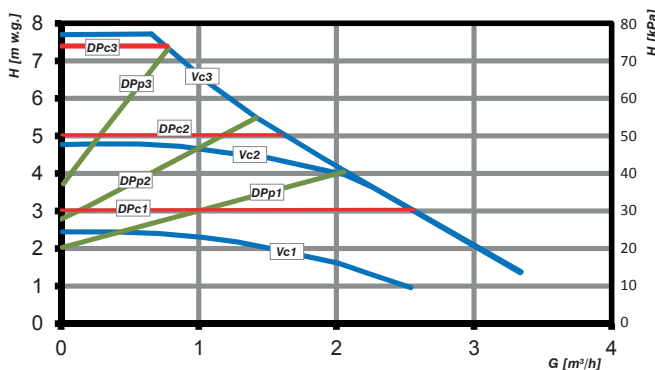

Vc: Constant speed
DPP: Proportional pressure
DPC: Constant pressure

Power of pump Wilo Para 15-130/7-50/SC-9

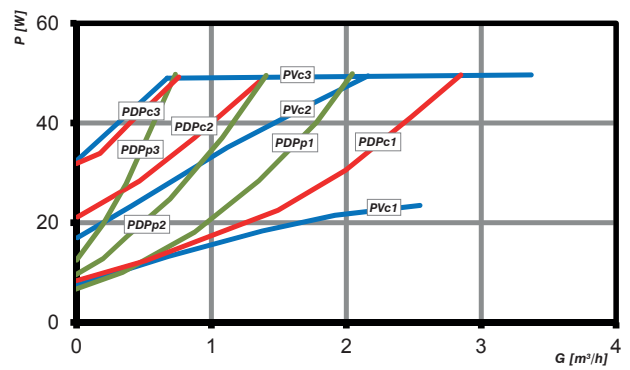

PVC: Power consumption at constant speed
PDPp: Power consumption at proportional pressure
PDPc: Power consumption at constant pressure

REGULATING GROUP WITH THERMOSTATIC MIXING VALVE DN 20

Head of pump Grundfos UPM3 AUTO 15-70 130

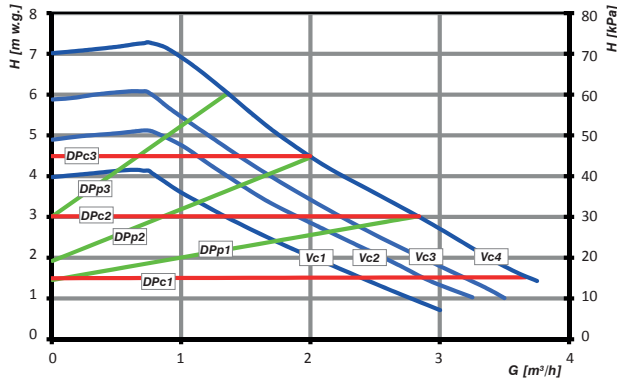

Vc: Constant speed
DPp: Proportional pressure
DPc: Constant pressure

Power of pump Grundfos UPM3 AUTO 15-70 130

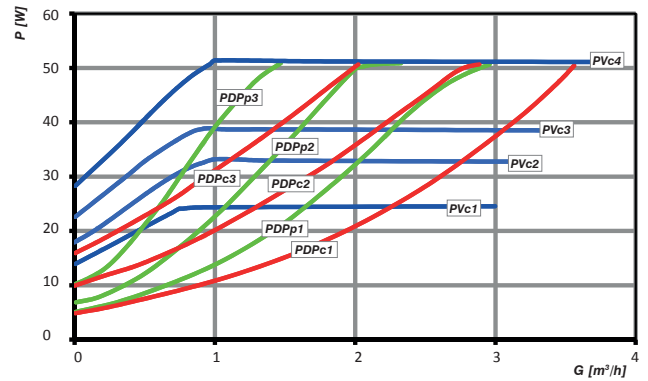

PVc: Power consumption at constant speed
PDPp: Power consumption at proportional pressure
PDPc: Power consumption at constant pressure

Head of pump Grundfos UPSO 15-65 130 (Extra EU)

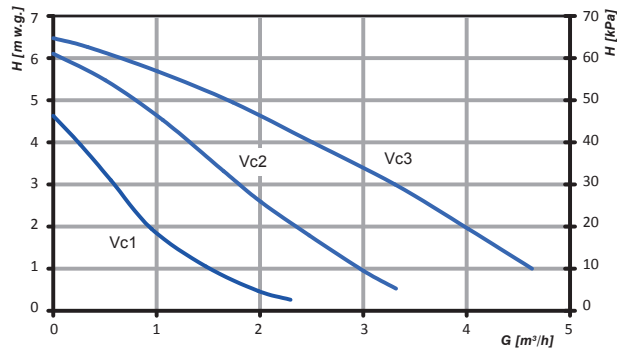

Vc: Constant speed

Power of pump Grundfos UPSO 15-65 130 (Extra EU)

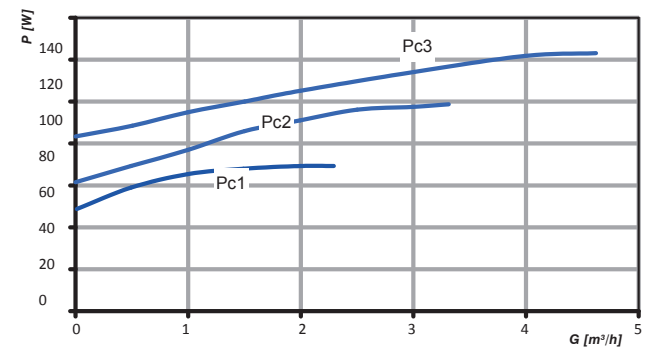

PVc: Power consumption

Features

The thermostatic regulating group consists of:

- Front insulation shell (1) upper and lower part,
- Rear insulation shell (2),
- Central front insulation shell (3),
- Flow line (4) including thermostatic mixing valve, shut-off valve, temperature gauge and pump,
- Return line (5) including ball shut-off valve, check valve and temperature gauge.

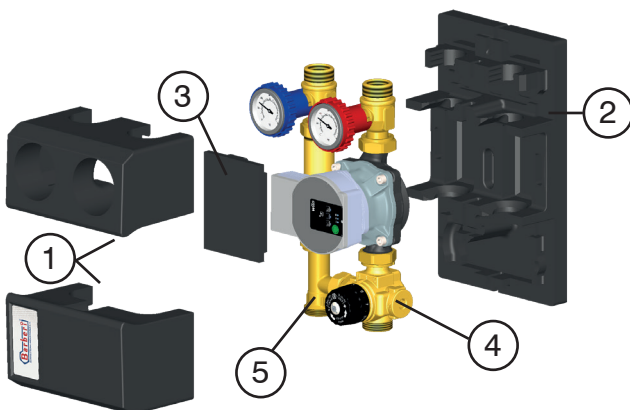

Advantages

Energy saving: the front (1) and rear shells (2) help the thermal insulation of the group and allow energy saving.

Pump protective shell (3): maintains the thermal insulation and avoids overheating of the pump electronic part. In this way the risk of damage is reduced.

Fast assembling insulation: the rear insulation shell (2) remains hanging to the group also after removing the front shell parts (1). This allows a fast and easy reassembling of the insulation after completing the work.

Compact installation: 90 mm centre distance with 130 mm pump connections makes the installation very compact.

Frontal devices: all devices, such as the pump menu, temperature gauges, shut-off valves and, in mixed groups, the thermostatic valve and actuator, are frontal. This allows fast regulation and functional check, in particular for the installation of several groups very close to one another.

Check valve with override: the groups are factory equipped with a check valve on the return line, placed within the monobloc with blue knob. By rotating at 45° the blue knob, it is possible to override the check valve function, thus allowing the water passage in two directions and making the filling phase of the system much faster. The mixed groups have the

REGULATING GROUP WITH THERMOSTATIC MIXING VALVE DN 20

T-fitting, connecting the mixing valve, suitable for the insertion of a further removable check valve insert.

Versatility of the wall mounting bracket: the universal bracket 42D.DN20 (accessory) makes it possible to install the group with flow upward, downward or with the group laying on a side. Pay however the maximum attention to correctly fix the group to the wall when installed laying on a side. The bracket, in addition to the traditional two side holes, has a third central hole to screw the group to the wall with one only central anchor, after making a specific hole in the insulation shell. This allows to fix the whole group to the wall already hanging to the bracket.

Transformability: in case of need, the groups are easily transformable from one version to another (eg. from direct distribution group to thermostatic, mixed and vice versa) as they share the vast majority of components.

Identical actuators for all DN: the motorized groups DN 20 can be combined with the same actuators of the DN 25 and DN 32 ranges, allowing a reduction of the models to be purchased and consequently of the warehouse.

Pump range: the groups are available with three different pump models. For the use of other models and/or manufacturers, it is advisable to contact Barberi for verification.

Quick pump replacement: the circulators can be quickly replaced without completely removing the rear insulation.

Flat gaskets: the various components of the groups are connected to each other by means of flat seal fittings. This makes the installation faster by avoiding the use of hemp or other sealants.

Cable glands: the insulation of the groups is equipped with cable glands pointing upward and downward to allow the cables to be laid safely and tidy.

Accessibility and maneuverability of the nuts: the insulation is designed in such a way as to leave the space necessary to maneuver all the nuts, with a suitable hexagonal key, without having to remove it. This is an advantage especially in the wall installation where the insulation is laying against the wall or when pipes pass behind the insulation.

The nuts are supplied loosened to facilitate the group reversion on the installation field. Fully screw the nuts before installing the group.

Installation

The mounting options of the group are:

- Wall installation
- Manifold installation

The group can be installed on manifolds with integrated hydraulic separator, on standard manifolds with independent hydraulic separator, on manifolds connected to a storage.

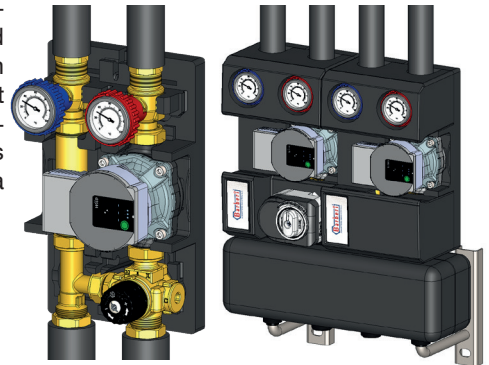

Group position

The group can be installed in one of the ways shown in the picture, with the pump rotation axis always horizontal.

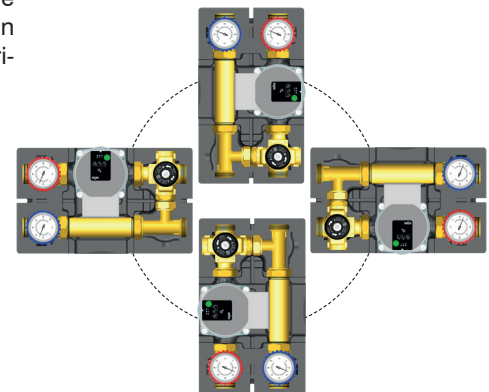

REGULATING GROUP WITH THERMOSTATIC MIXING VALVE DN 20

Group reversibility

The group is factory set with pump on the RH side and flow upwards (or, by rotating it, pump on the LH side and flow downwards). The reversibility is allowed on the installation field by the following procedure:

1) Fully unscrew the T-joint from the mixing valve.

2) Exchange the flow line (1) with the return one (2), by rotating the extension, connected to the T-joint, 180° around its vertical axis.

3) Exchange between them the position of the plug and fitting located on the two return ports of the mixing valve.

4) Connect all the components again and fully screw the nuts. Warning: due to the presence of a check valve, keep the ball shut-off valve with red knob on the pump line and the blue knob on the return. For some pump models, it is necessary to rotate the electronic part to place it within the insulation.

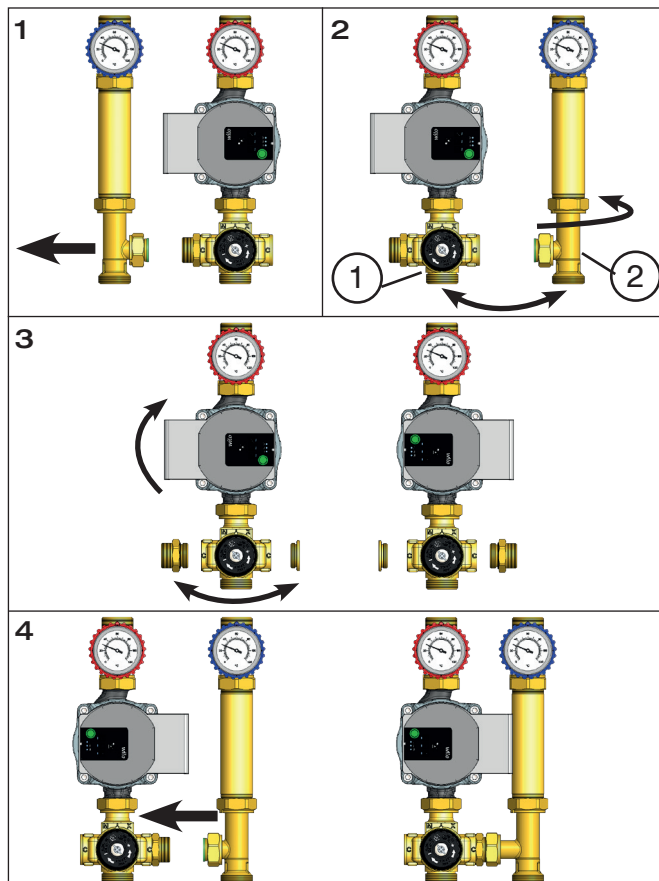
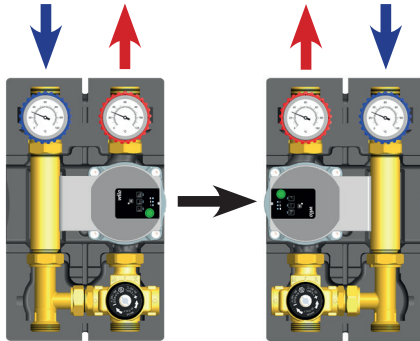

Adjustment of thermostatic mixing valve

The thermostatic mixing valve keeps constant the temperature of the water supplied to the system. The fixed point regulation is achieved through a thermostatic sensor which moves thanks to the expansion of the wax inside of it. The sensor integrated within the valve is more precise and reliable than the thermostatic valves with external capillary.

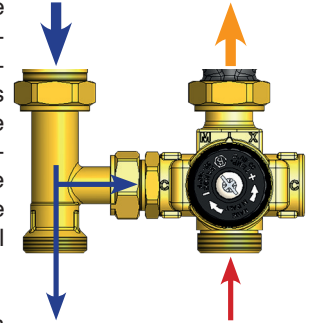

The knob is equipped with a anti-tamper mechanism which makes the rotation difficult, thus avoiding undesired set changes. The mechanism can be released with a screwdriver, slightly loosening the locking screw.

FIRST SYSTEM START UP. The fixed point temperature value can be set with the knob before installing the group or, after the installation, exclusively with the SYSTEM COLD. To set a temperature value different from the factory one, proceed as follows:

1) The graduated scale on the knob corresponds to the temperature values shown in the table below.

2) With a screwdriver, slightly loosen the locking screw, holding the knob with your hand.

3) Set a mixed water temperature value slightly lower than the design temperature. Activate the generator and wait until it reaches its design working temperature (higher than the valve setting). Activate the pump group. Wait until the mixed water temperature gets stable. Read its value on the flow temperature gauge.

4) Counterclockwise rotate step by step the knob to increase the

	25-50 °C	30-60 °C
Min	20 °C	30 °C
1	25 °C	34 °C
2	30 °C	38 °C
3	35 °C	41 °C
4	38 °C	43 °C
5	41 °C	45 °C
6	43 °C	47 °C
7	45 °C	50 °C
8	47 °C	54 °C
Max	50 °C	60 °C
Factory setting	38 °C	45 °C

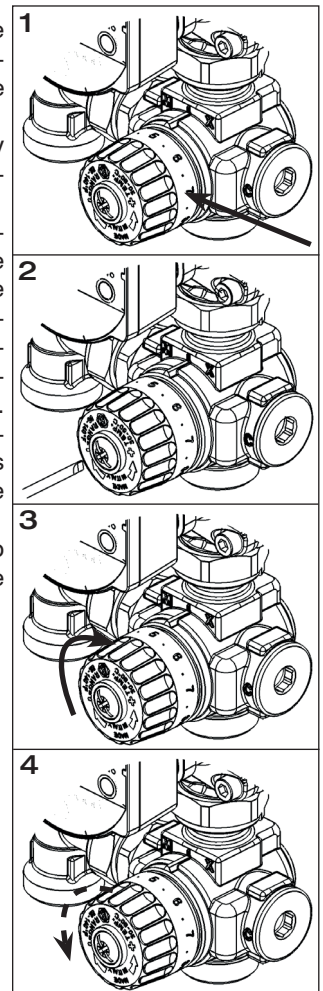

REGULATING GROUP WITH THERMOSTATIC MIXING VALVE DN 20

temperature. Then wait until the temperature gets stable. Read its value on the flow temperature gauge. Proceed in the same way until the design temperature is reached.

5) When the desired temperature is reached, close the locking screw, holding the knob with your hand.

NEXT SETTING. If later a change should be needed in the valve setting, proceed as follows.

Case 1: temperature lower than the current setting. Let the system get cold to obtain at least a return temperature lower than the new valve setting. Follow points 1, 2, 3, 4 and 5.

Case 2: temperature higher than the current setting. In this case, the setting can be carried out also with the system running as well as with the system cold. Follow points 1, 2, 4 and 5.

System diagrams

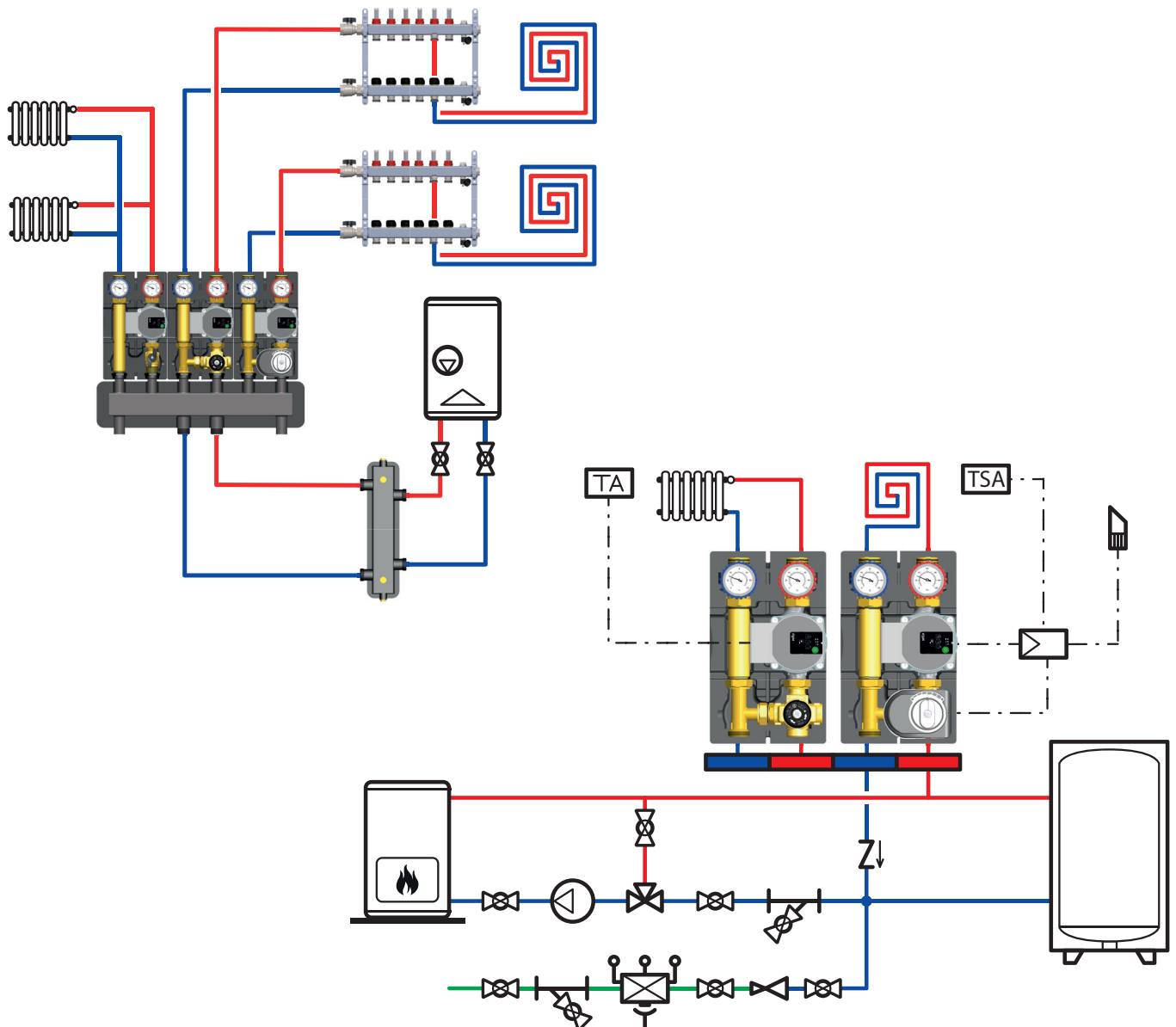

REGULATING GROUP WITH THERMOSTATIC MIXING VALVE DN 20

Accessories

42D.DN20

Bracket for wall mounting of the distribution and regulating group, with screws and anchors

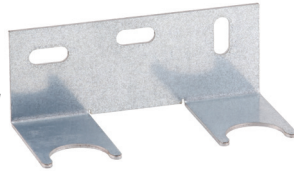

Hole centre distance: **45 mm**

Hole diameter: **8 mm**

Code



42D 020 Z00 I

1

25

Specifications

Series 02G.DN20

Regulating group with thermostatic mixing valve. G 1 M connections with plane gaskets to the primary circuit and G 1 M+ G 3/4 F double thread connection to the secondary circuit. Centre distance between flow and return connections 90 mm. Height of flow and return lines 277 mm. Dimensions of the group with shell 179x298x139 mm (Width x Height x Depth). The group is composed of: thermostatic mixing valve in brass with wax thermostatic sensor, adjustment range 25–50 °C (and 30–60 °C); ball shut-off valves in brass on the flow and return of the secondary circuit; POM check valve on the return line; flow and return temperature gauges with 0–120 °C scale. High-efficiency pump Wilo Para 15-130/7-50/SC-9 (Grundfos UPM3 AUTO 15-70 130, 3 constant speed pump Grundfos UPSO 15-65 130 (Extra EU)), electric supply 230 V (50 Hz). Insulation shell in EPP. Working temperature range 5–90 °C. Maximum working pressure 10 bar.